

涂装同标贴指示

Painting & Marking guide

PAINT REFERENCE COLOUR

Color	Mr.Hobby	Vallejo	Model Master	Tamiya	Humbrol
Metal Black 黑铁色	H 18 28	864	1402	-	-
Russian Green(2) 苏联绿	H 136	823	-	-	-

A

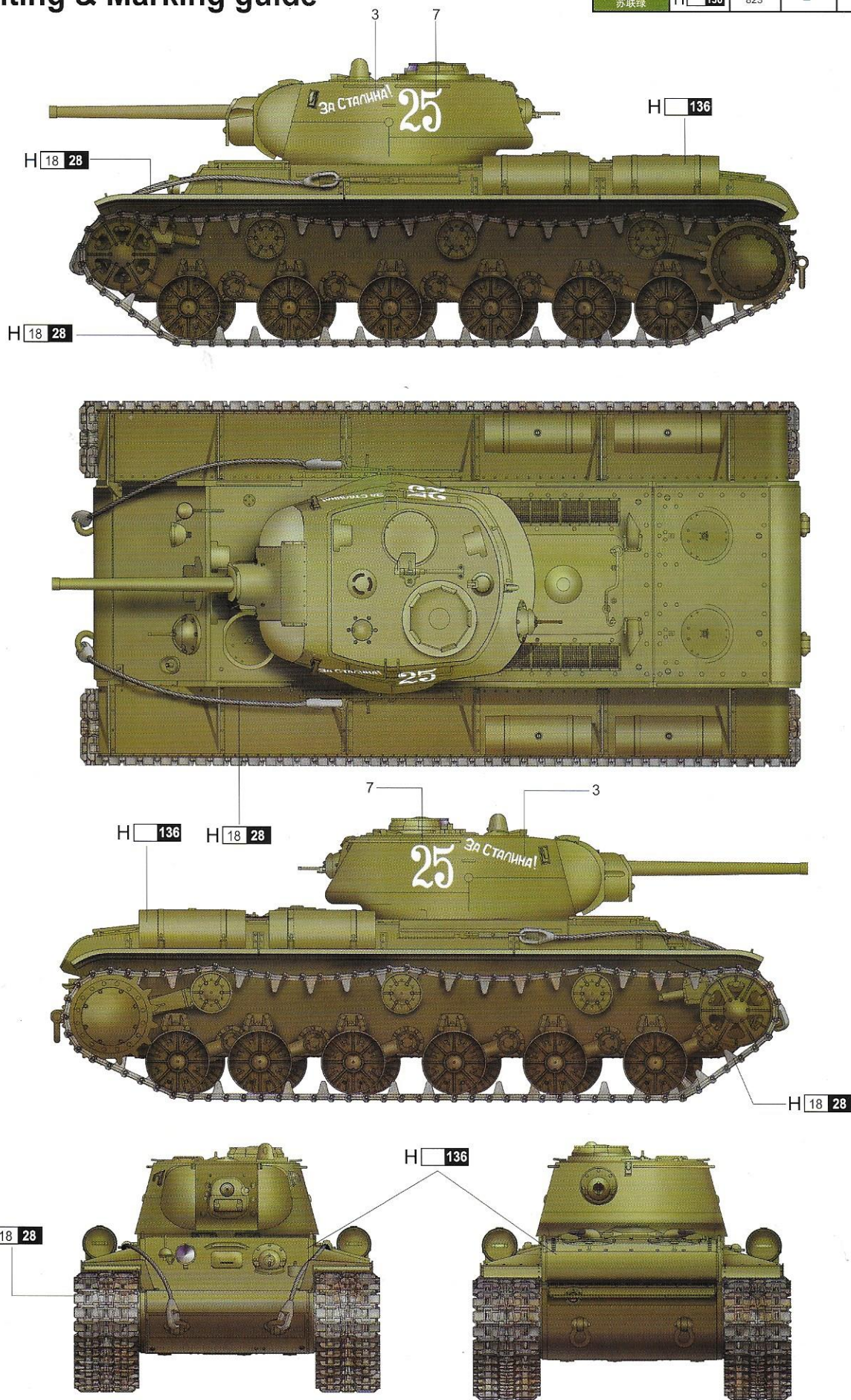

H AQUEOUS HOBBY COLOR

■ Mr. COLOR

涂装同标贴指示 Painting & Marking guide

PAINT REFERENCE COLOUR

Color	Mr.Hobby	Vallejo	Model Master	Tamiya	Humbrol
Mahogany 桃木色	H[84 42]	846	—	—	160
* Metal Black 黑铁色	H[18 28]	864	1402	—	—
White Insignia 白色	H[316 316]	991	1745	X2	22
Russian Green(2) 苏联绿	H[136]	823	—	—	—

B

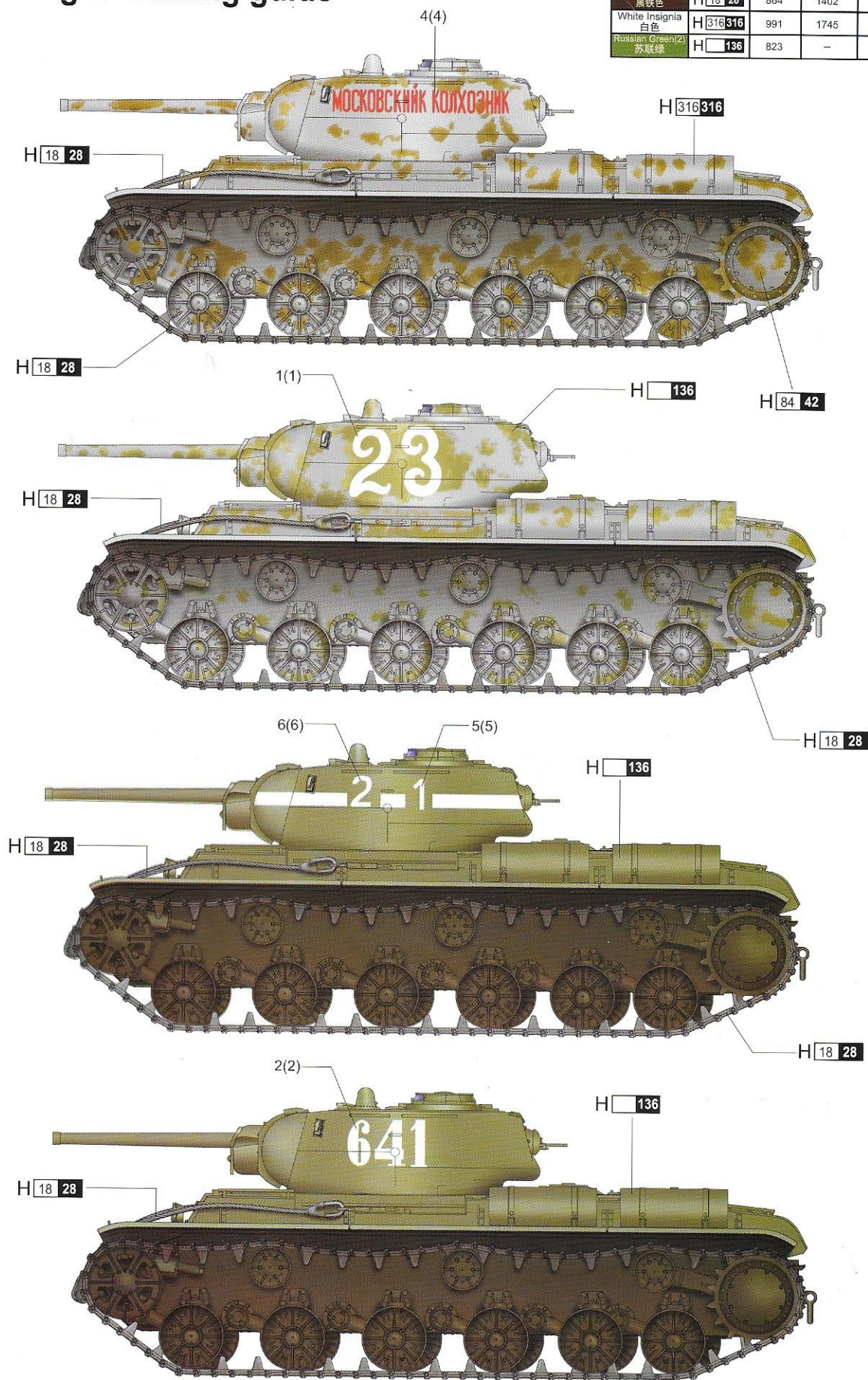

H AQUEOUS HOBBY COLOR ■ Mr. COLOR

Soviet KV-1S Heavy Tank

苏联KV-1S重型坦克

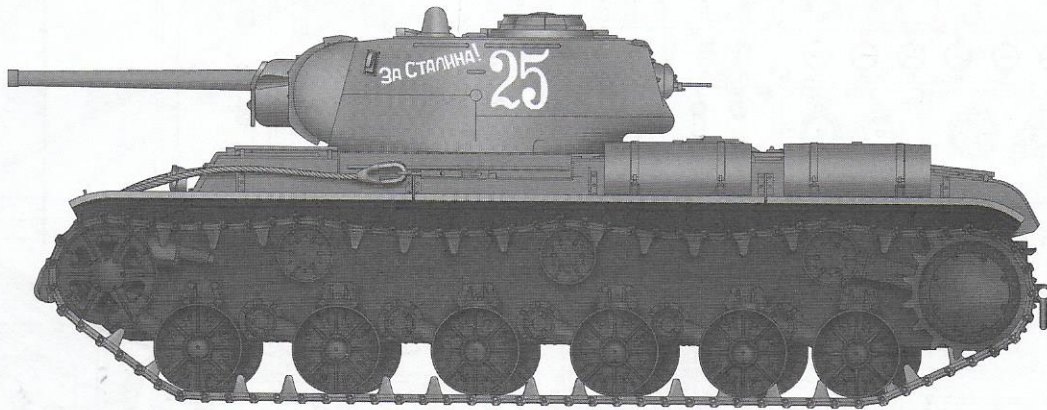

READ BEFORE ASSEMBLY:

- Study and understand these instructions thoroughly before beginning assembly
- When needed, remove photo-etch parts carefully using a modeling knife or photo etch sprue cutter, being careful not to damage or lose small parts.
- Take extra care in handling photo etch parts in order to avoid injury
- Apply instant cement sparingly to photo etch parts where instructed
- Tools recommended(not included in kit):Plastic and instant cements,sprue cutters,long nose pliers,,modeling knife, small files, tweezers, pin vise & scissors. Soft cloth and sandpaper will also assist in construction
- Glue and paint are not included in the kit. Use plastic cement and hobby paints only. Color guide for purchasing paint is included in the kit.

装配之前仔细阅读

- 小心用模型锉刀锉平所有零件表面的注射浇口。
- 小心用刀片切下蚀刻片零件，不要遗失小零件。
- 用强力快干胶水粘合蚀刻片零件和金属轴。过量的快干胶水使用可能导致可动零件会粘住，小心涂胶。
- 取蚀刻片时应特别注意安全，防止利边划伤手指。
- 某些零件表面需贴水上贴纸，请选择在装配的同时进行。
- 推荐模型工具(自备)：胶水，水口剪刀，长咀钳，刀片，锉刀，镊子，钳，钻，剪刀，瞬间快干胶。
- 软布同砂纸同时也应该是必备工具。
- 请使用塑料胶水和油漆，模型内不含。



cyanoacrylate glue
使用强力胶



weight
配重



make hole
钻孔



cut / remove
切除



bend
弯曲



file / sand
锉平



option
选择



no cement
不涂胶水



decal
贴纸

水贴纸的使用:

1. 从水贴上剪下印花;
2. 将印花放入温水中浸10秒, 然后放在干净布上。
3. 拿着印花纸板将印花移到模型上;
4. 手指蘸水将印花移到适当的位置;
5. 用软布轻压印花直至水干, 气泡消失。

DECAL APPLICATION:

1. Cut decals from sheet as needed
2. Dip the decal in warm water for about 10 seconds and then place on soft clean cloth.
3. Hold the decal backing sheet edge and gently slide the decal onto the model in its proper position.
4. While still wet, decal can be adjusted for better fit on model by dampening it gently with your finger.
5. When placed in the proper position, gently press decal down with a soft cloth until excess water and air bubbles are gone.
6. Allow decal to dry completely before handling model

部品图
Parts

WAx2

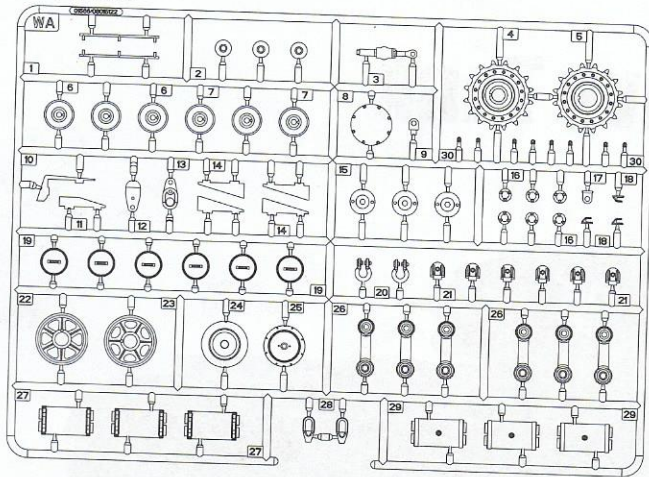

WB

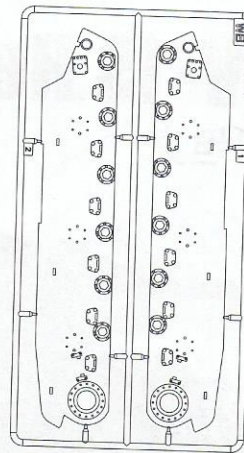

《车底》
Lower hull

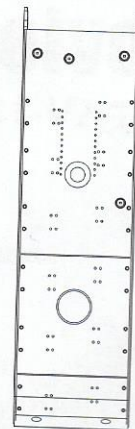

WC

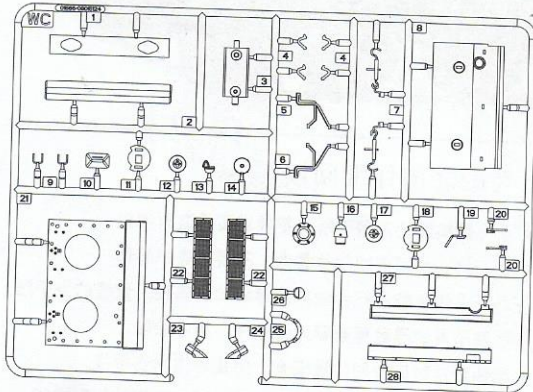

WH

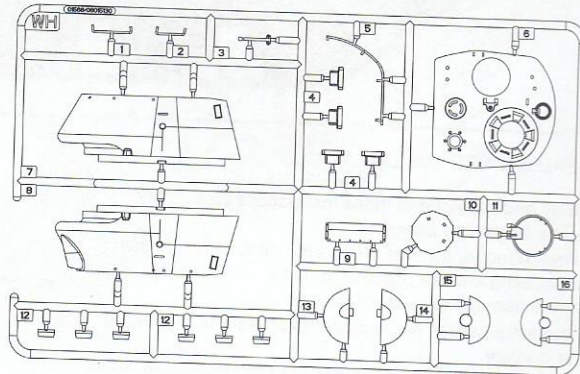

WG

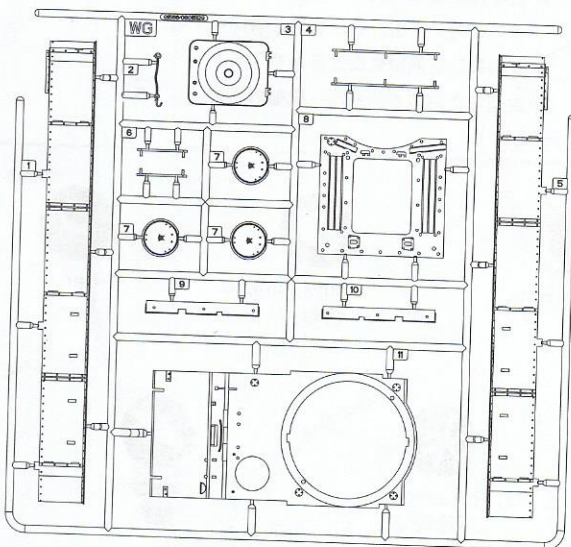

WDx3

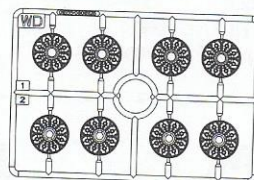

WTx12

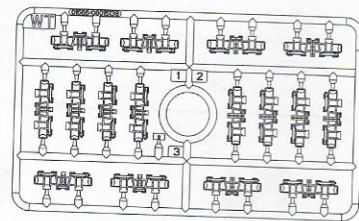

WP

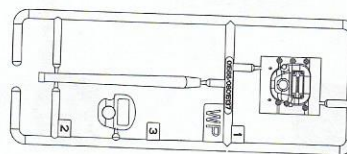

S

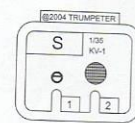

《金属炮管》
Metal barrel



《铜缆》 \varnothing 1.0x150mm
Brass wire

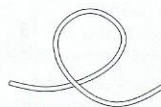

《蚀刻片》 - A
Photo etched

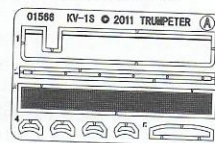

《水贴》
Decal



不用部件: WC15、WC27。
Unused parts

01566

01566

1

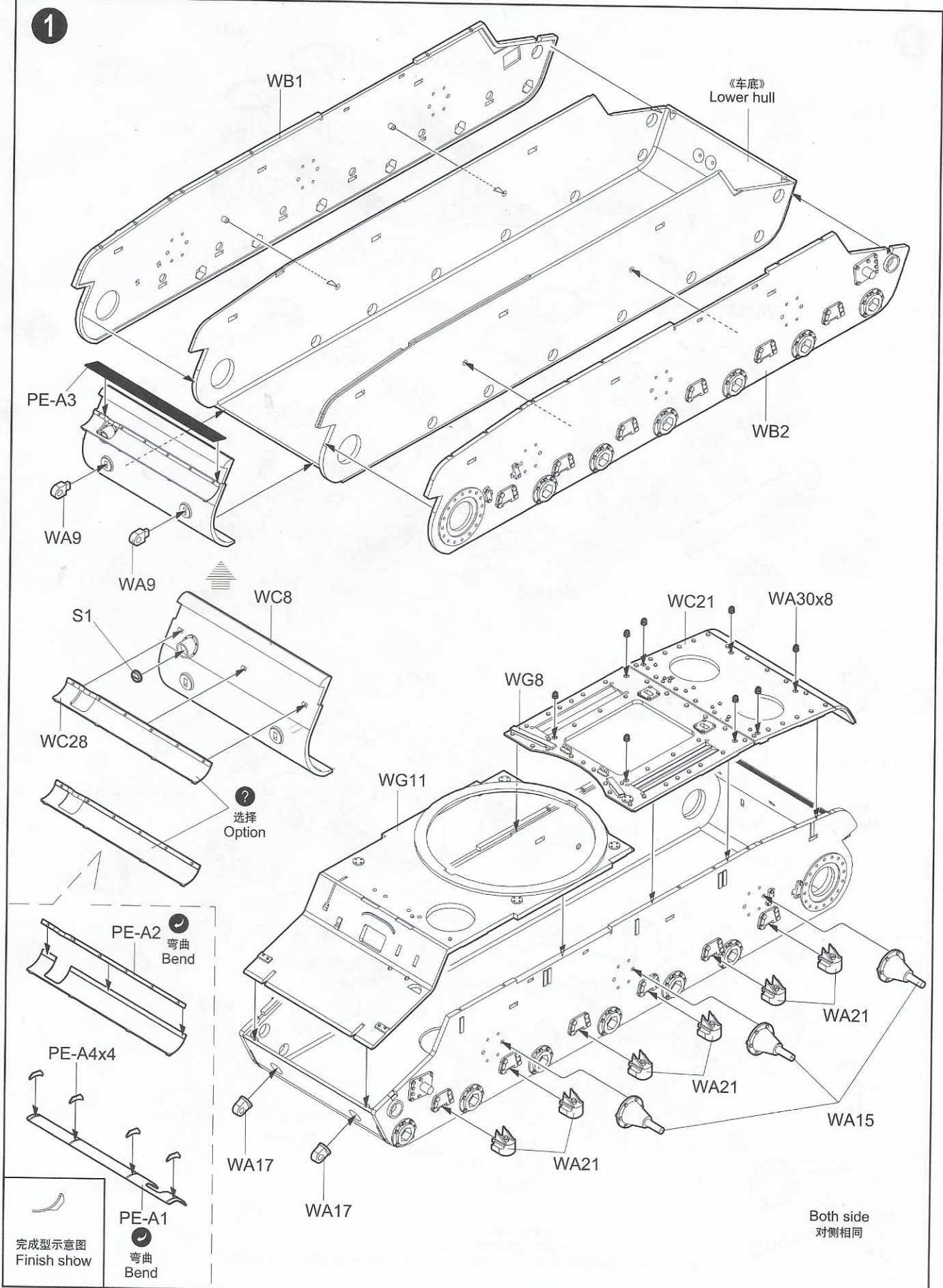

01566

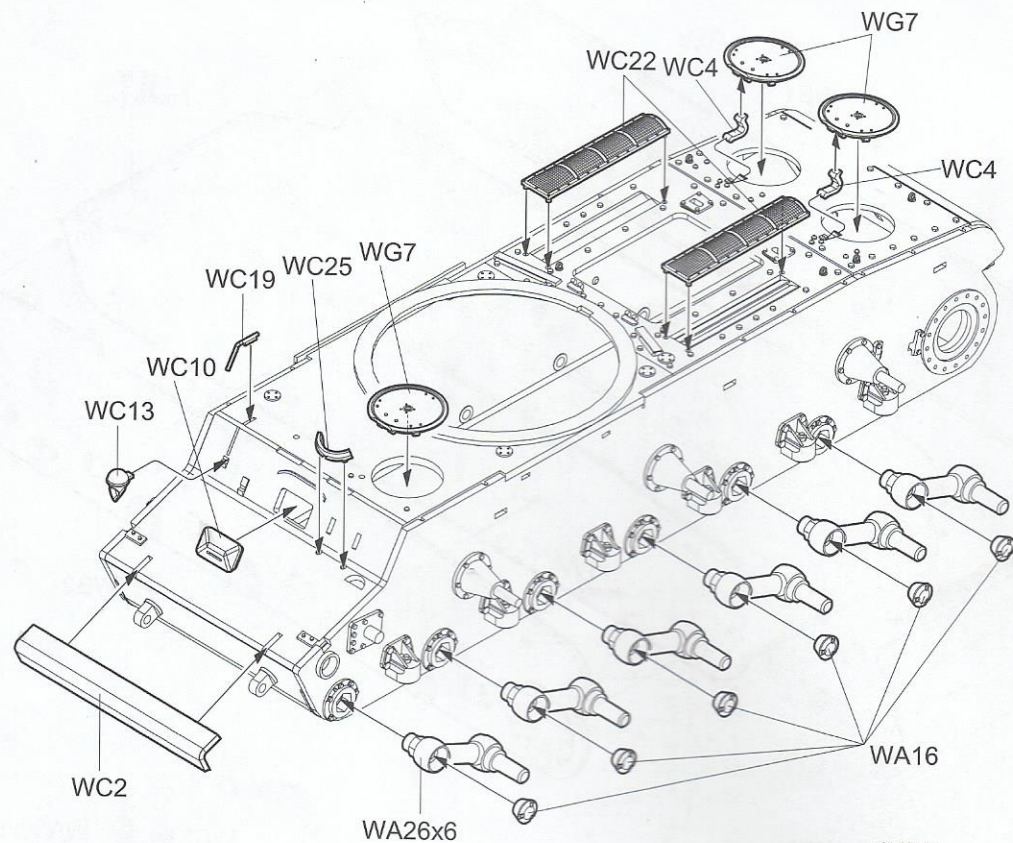

对侧相同
Both side

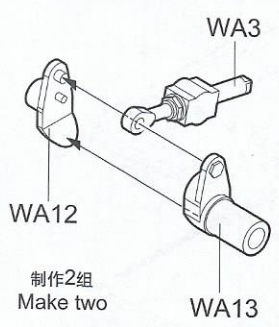

《履带张紧器》
Track tightener

制作2组
Make two

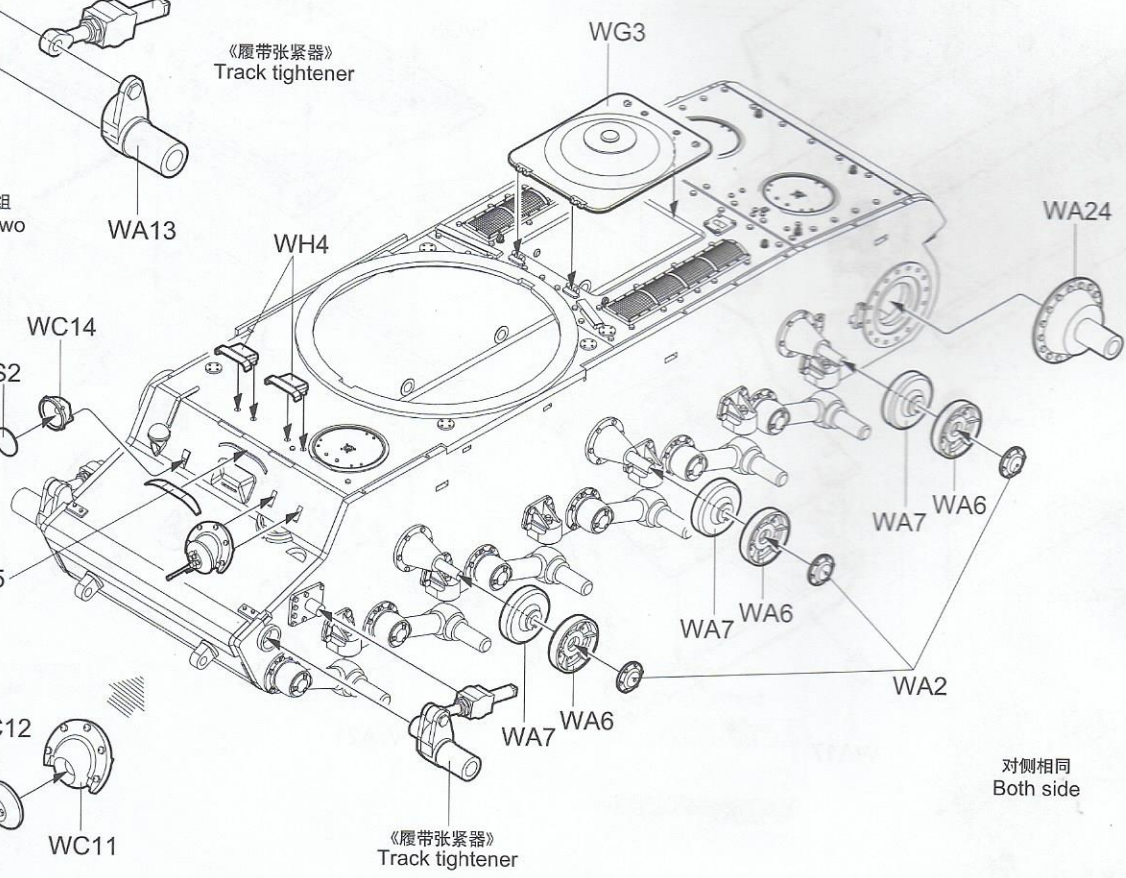

对侧相同
Both side

《履带张紧器》
Track tightener

PE-A5
弯曲
Bend

3

《负重轮》
Road wheel

制作12组
Make twelve

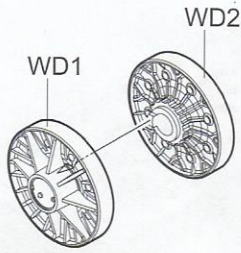

《主动轮》
Sprocket wheel

WA8

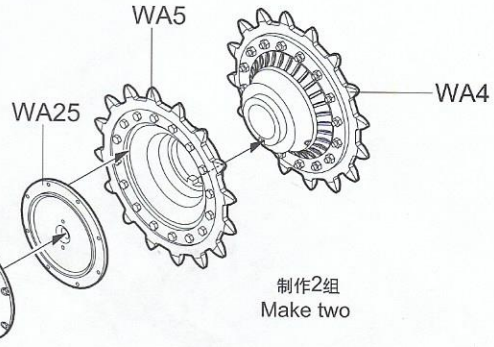

制作2组
Make two

4

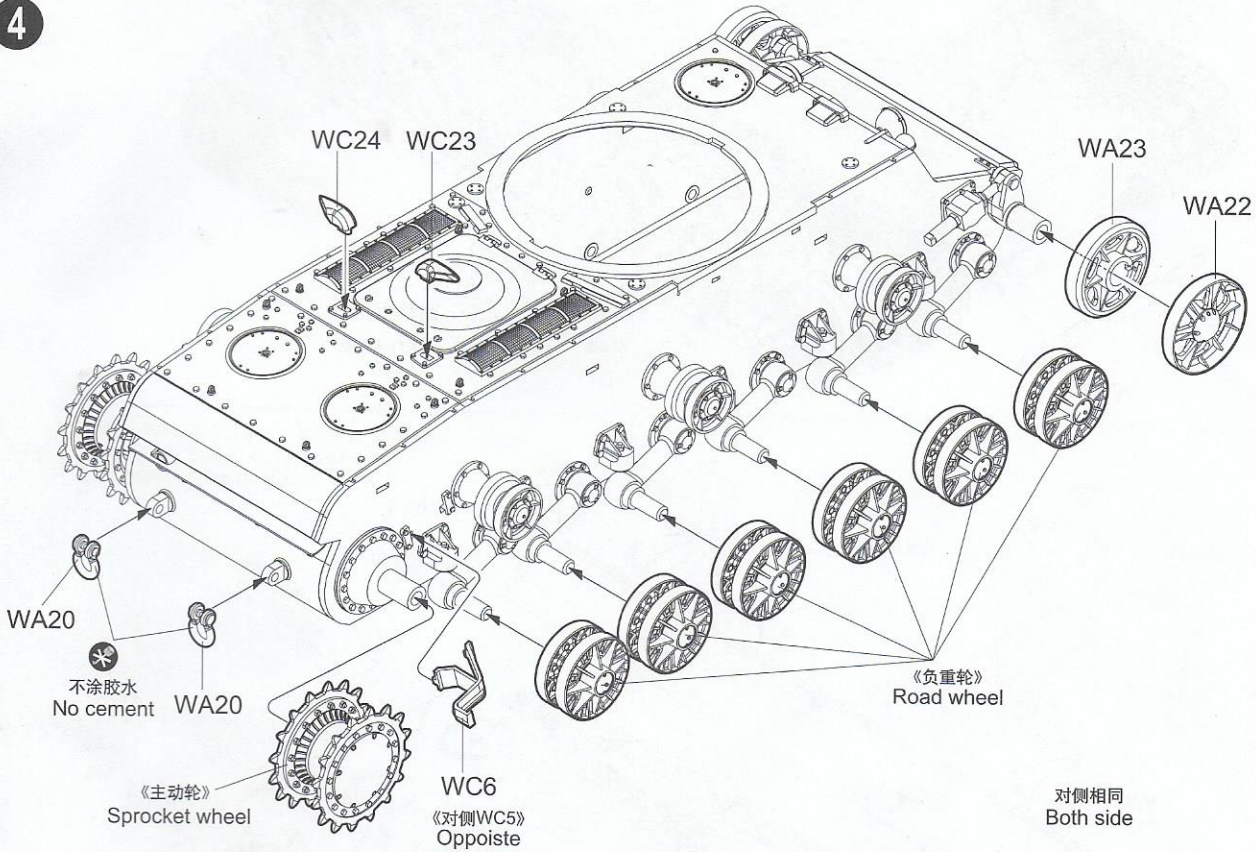

WA20
不涂胶水
No cement

《主动轮》
Sprocket wheel

WC6
《对侧WC5》
Opposite

《负重轮》
Road wheel

对侧相同
Both side

5

履带联接
Track construction

《单侧履带需88节》
Complete track for one side require 88 links

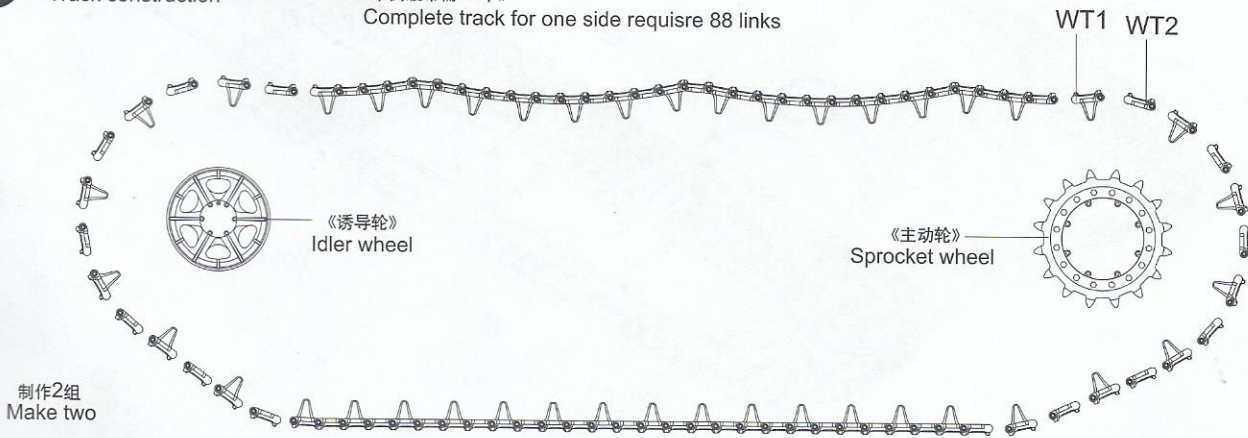

《诱导轮》
Idler wheel

《主动轮》
Sprocket wheel

制作2组
Make two

6

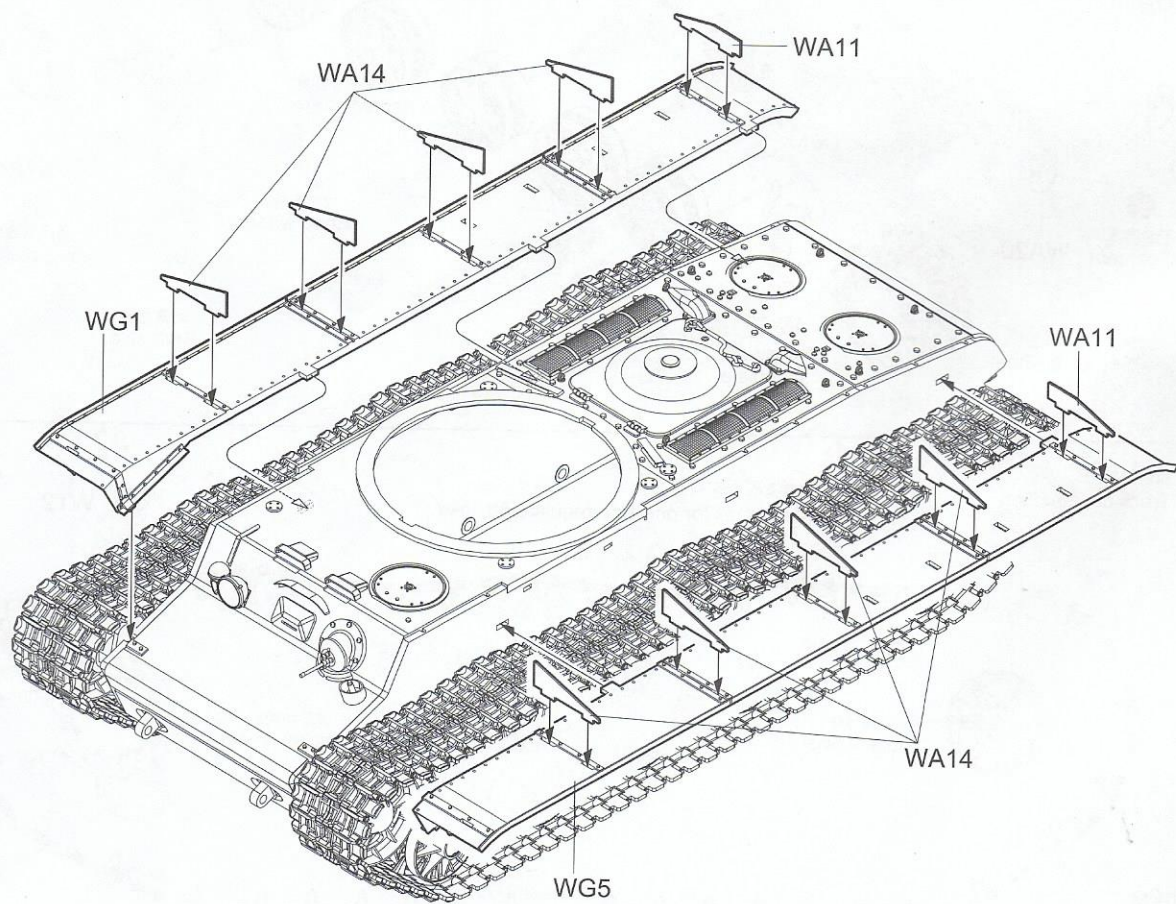
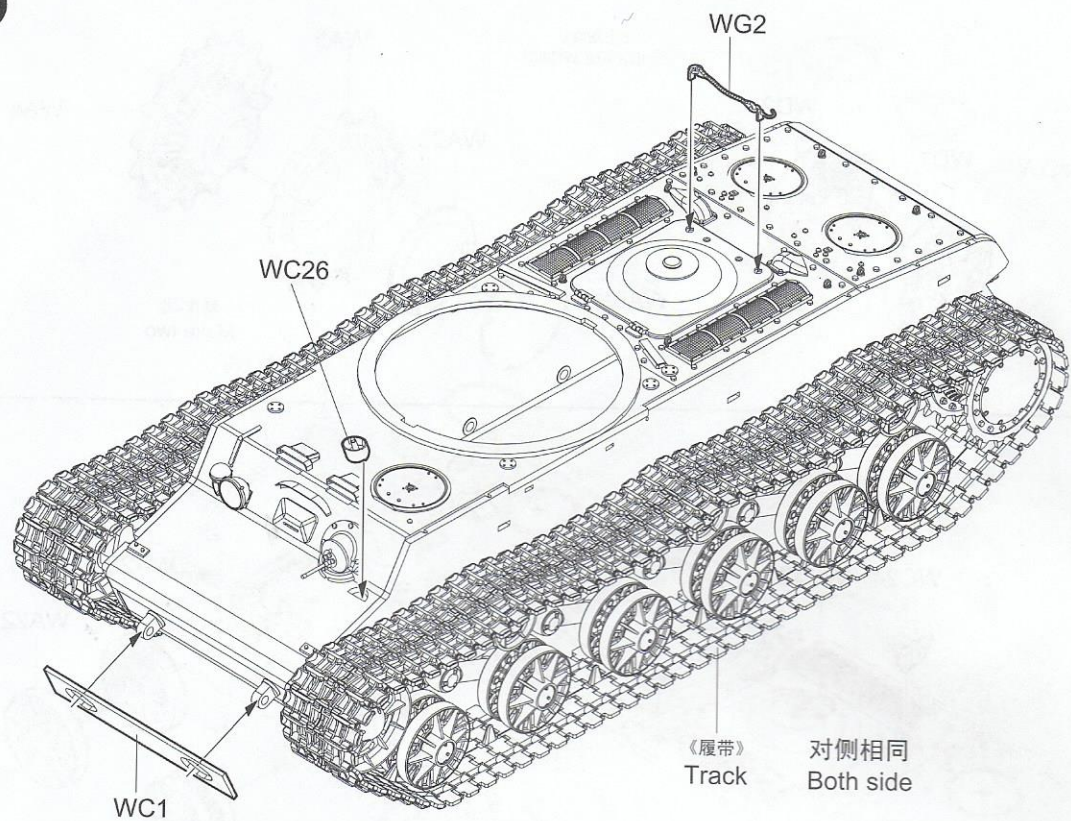

7

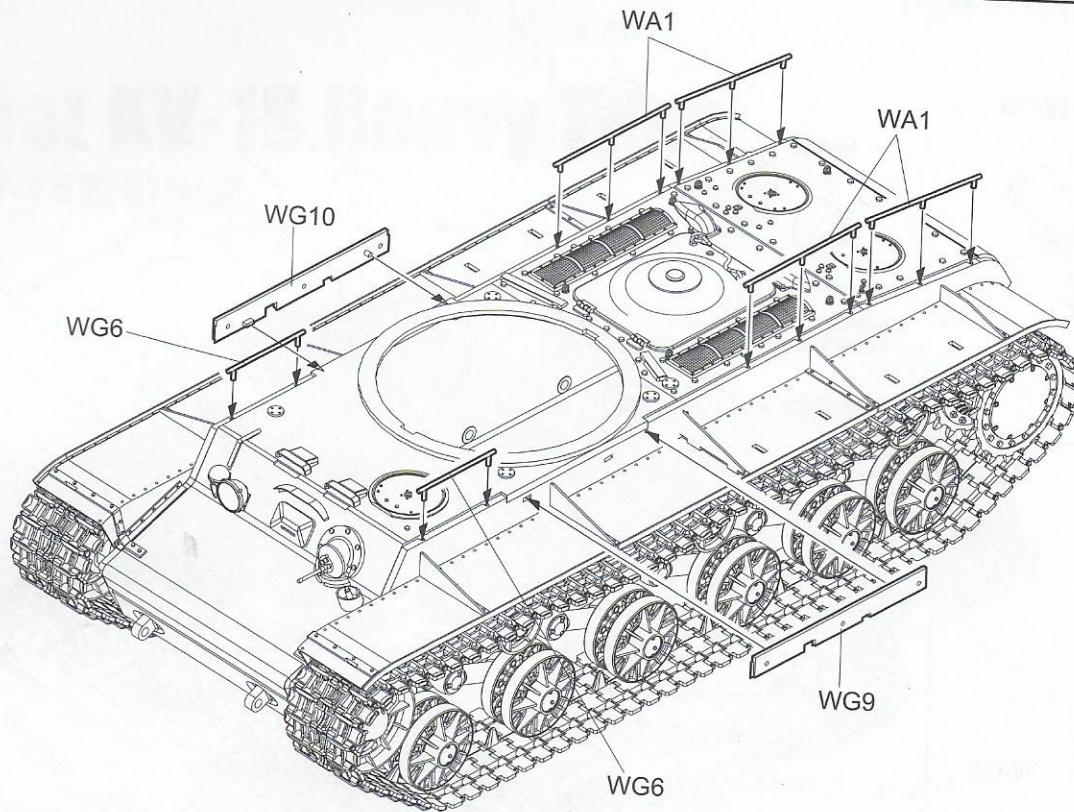

8

WH1 WH2 WA18 可选装或不装, 则切除填补安装位置。
 Assembly option or no assembly,
 and delete install position.

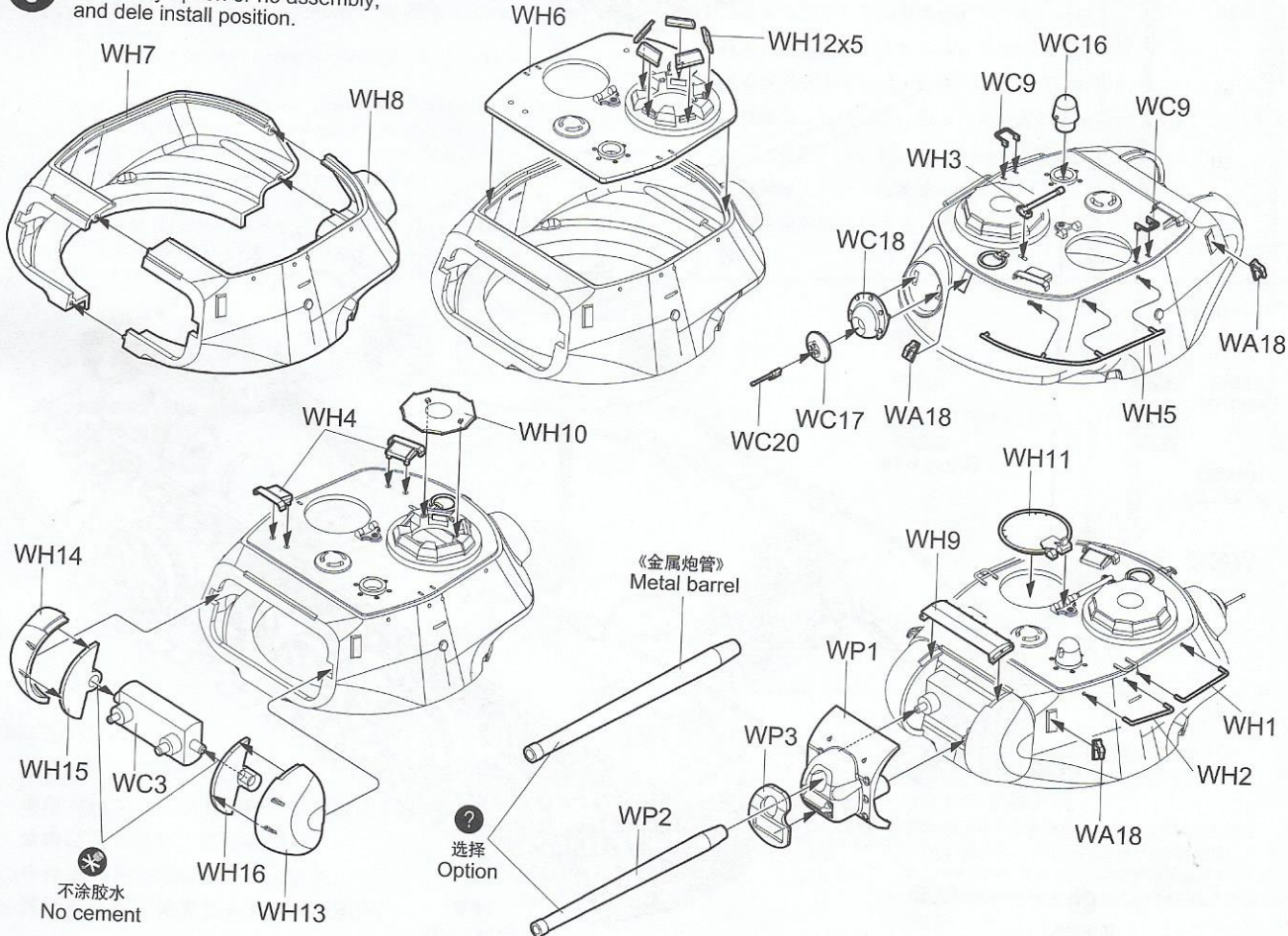

9

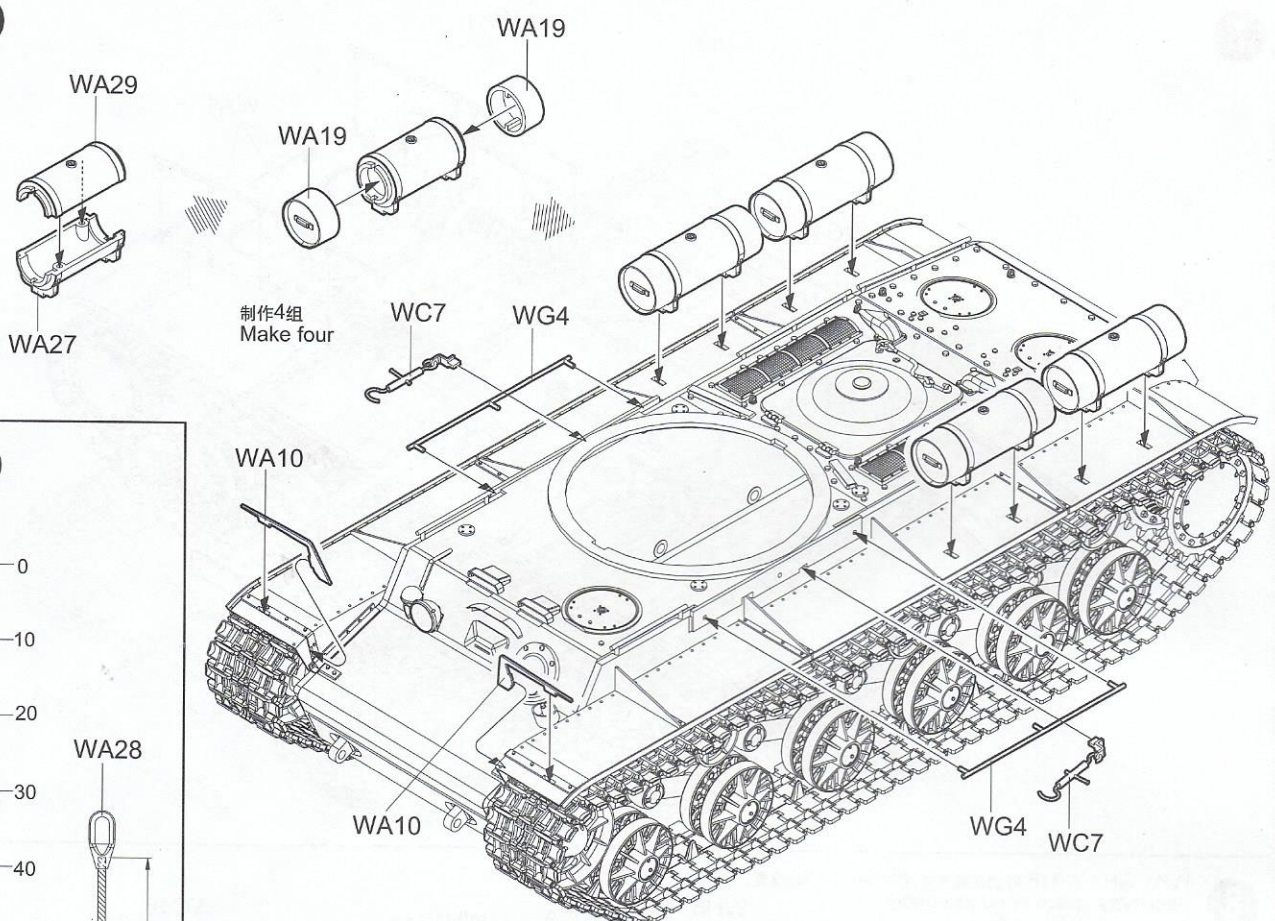

10

